

## TABLES MARSELLA

Designed by **David Carrasco Barceló**

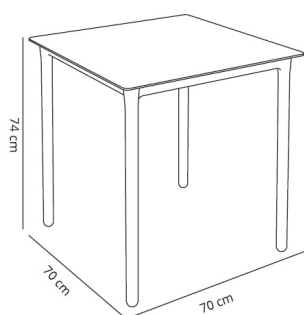

### TABLES MARSELLA

Stackable table for indoor and outdoor use with screwed polypropylene and fiberglass legs. Tabletop manufactured from two pieces injected in polypropylene additive with UV protection and welded by vibration.

#### TABLE FEATURES

**W** 70cm x **L** 70cm x **H** 74cm

**W** 27.56in x **L** 27.56in x **H** 29.14in







**Weight** 5,7 Kg. | **Stackable** 5 Units

STD units	Packaging dim. (cm)	Units Container 20'	Units Container 40'	Units Container HC	Units Traylor 70m <sup>3</sup>	Units Truck 100m <sup>3</sup>
1X	79 x 79 x 7.5	297	675	675	891	972
P27	80 x 80 x 220	297	675	675	891	972

#### TABLETOP

	 Sand	 White	 Dark Grey
70x70cm	<input type="checkbox"/>	<input type="checkbox"/>	<input type="checkbox"/>

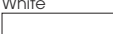
#### TABLETOP/PEDESTALS

	 Sand	 White	 Dark Grey
 Sand	<input type="checkbox"/>	<input type="checkbox"/>	<input type="checkbox"/>
 White	<input type="checkbox"/>	<input type="checkbox"/>	<input type="checkbox"/>
 Dark Grey	<input type="checkbox"/>	<input type="checkbox"/>	<input type="checkbox"/>